

Lighting Standards

**Kentucky
High School
Athletic Association**



TABLE OF CONTENTS

Standards of Lighting	4
I. Recommended Minimum Standards	4
PART 1 – GENERAL.....	4
1.1 LIGHTING PERFORMANCE	4
1.2 ENVIRONMENTAL LIGHT CONTROL.....	6
1.3 LIFE-CYCLE COSTS.....	6
1.4 CONTROL AND MONITORING SYSTEM	7
1.5 WARRANTY AND GUARANTEE.....	7
PART 2 – PRODUCT.....	7
2.1 LIGHTING SYSTEM CONSTRUCTION	7-8
2.2 STRUCTURAL PARAMETERS	8
PART 3 – EXECUTION	9-9
3.1 FIELD QUALITY CONTROL	9-9
II. Desirable Features	9
4.1 TV QUALITY LIGHTING.....	9
4.2 AUXILIARY BRACKETS	9
4.3 SCOREBOARDS	9
4.4 FIELD PERIMETER LIGHTING	10
LIFE-CYCLE OPERATING COST EVALUATION.....	11
SUBMITTAL INFORMATION	12
Appendix	13
Typical Facility Information.....	13
Light Level Grid Point Layouts.....	13
Pole Location Diagrams	16
ANNUAL SYSTEM OPERATION & MAINTENANCE CHECKLIST.....	27
Lighting Performance Testing	28
Glossary.....	36

Standards of Lighting

The standards in this manual were originally adopted by the Kentucky High School Athletic Association as a result of recommendations by a Standards Advisory Committee. These standards were adopted by the Board of Control in July, 1999, and the most recent revisions were made in February, 2011. These recommended standards apply to the lighting of all athletic activities sponsored by the KHSAA or its member schools.

These standards incorporate the most current data available regarding the lighting, electrical, and structural issues that apply to installation of a safe, effective lighting system.

The standards are divided into recommended minimums and desirable features. The minimums establish criteria important to the proper conduct of KHSAA activities and include evaluation of operating costs over the expected life of the lighting system. Desirable features are established to give added values where appropriate for a facility's needs.

These recommendations will be used in selected sports as part of the criteria used to determine championship sites when the KHSAA makes site selections. The standards as originally published comply with the requirements of and recommended by the Department of Facilities Management for the Kentucky Department of Education.

I. Recommended Minimum Standards

These minimum standards are recommended for all lighting installations after the date of adoption of these standards. Any modification in existing lighting systems after this date should be done so as to result in a lighting system in compliance with these standards. To be in compliance, a system must meet all recommended minimum standards.

PART 1 – GENERAL

1.1 A. Light Levels – Optic System Performance

The quantity of equipment needed to produce the target light levels on a field is determined by the efficiency of the lighting system. Newest technology is capable of delivering equal or better results with as little as half the amount of equipment as common floodlighting systems. This generation of lighting has high performance optic characteristics that enable reductions in the quantities of luminaires needed to meet design targets. The lighting designs for the specified field will show a reduced fixture count for systems using a high-performance optic system. Manufacturers should provide assurance that target light levels will be met over the life of the system.

B. Light Levels – Sustaining Targets Over Time

The two methods of design to meet specified light levels are: to provide a constant light level during the guarantee period, or to apply a recoverable light loss factor to the initial design.

1. Preferred Technology – Constant Light

By using a series of automatic power adjustments, a lighting system is able to provide “constant light levels,” greatly extend the life of the lamps, and reduce energy consumption. The basics of this method are described under “Lumen Maintenance” in the IESNA Lighting Handbook Reference and Application, Ninth Edition, page 27-2 and 27-3: “Lumen maintenance control strategy calls for reducing the initial illumination of a new system to the designed minimum level. As lumen depreciation occurs, more power is applied to the lamps in order to maintain constant output.”

The term constant is intended to include any system that provides target light levels at 100 hours and maintains the target light levels throughout the system life. Light levels should be guaranteed for 25 years with this technology.

Manufacturers should provide an independent test report signed by a licensed professional engineer certifying the lumen maintenance strategy and field performance of any constant light system.

2. Floodlighting with a Recoverable Light Loss Factor

Computer designs are done using two sets of values. One shows the calculated “initial light levels” when lamps are new. The other predicts “target maintained light levels” after the lamps have

passed through depreciation in light output. It is important to have the lighting designer use a maintenance factor adequate to account for this depreciation in light output throughout the life of the lamp.

According to best sports lighting practices, the recoverable light loss factor, or the value applied to the initial light level to predict the maintained light level values, should be in accordance with recommendations in the Pennsylvania State University report “Light Loss Factors for Sports Lighting,” published in IES’s *Leukos*, Vol. 6, No. 3, Jan., 2010, pages 183-201. The report’s findings show a recoverable light loss factor of 0.69 should be used if lamps will be replaced at 2100 hours. If lamps will be replaced at a different interval, the following chart from the report should be used to determine the appropriate recoverable light loss factor. Quality manufacturers are willing to provide guarantees of lighting performance.

Group lamp replacement interval	Recoverable Light Loss Factor
750 hours	0.80
1200 hours	0.75
2100 hours	0.69
3000 hours	0.65

C. Performance Requirements – Quantity

Playing surfaces shall be lit to an average target light level and uniformity as specified in the following chart. Lighting calculations shall be developed and field measurements taken on the grid spacing with the minimum number of grid points specified beginning on page 13 of these standards with the light meter held horizontally 36 inches above the field surface. Measured average illumination level shall be measured at the first 100 hours of operation.

D. Performance Requirements – Quality

Uniformity of the lighting shall be such that the highest measure of quantity of light on the field is not greater than the lowest measurement per the ratio listed in the table below. On the entire field area, the change in the quantity of horizontal footcandles should not occur at a greater rate than 10 percent per 10 feet, except for the outside perimeter readings which may change at a greater rate.

Area of Lighting	Target/Constant Light Levels (Avg)	Max to Min Ratio
Baseball/Softball Infield Area	50 footcandles	2.0:1
Baseball/Softball Outfield Area	30 footcandles	2.5:1
Football/Soccer/Lacrosse/Field Hockey (Facilities with up to 2000 spectators)	30 footcandles	2.5:1
Football/Soccer/Lacrosse/Field Hockey (Facilities with up to 5000 spectators)	50 footcandles	2.0:1
Tennis	40 footcandles	1.7:1 within lines 2.0:1 principal playing area
Gymnasiums (For practice or recreational purposes only)	50 footcandles	2.0:1
Gymnasiums (For hosting events with spectators)	80 footcandles	2.0:1
Track, Competitive Use	30 footcandles	3.0:1
Track, General Use (walking track)	5 footcandles	NA
Natatoriums	Consult an experienced lighting manufacturer or lighting specialist	
Note: Combination/Multipurpose areas must meet the highest average among the standards for activities played on the field		

Lighting performance requirements for constant light technology systems

Area of Lighting	Initial Light Levels (Avg)	Target Light Levels (Avg)	Max to Min Ratio
Baseball/Softball Infield Area	72.5 footcandles	50 footcandles	2.0:1
Baseball/Softball Outfield Area	43.5 footcandles	30 footcandles	2.5:1
Football/Soccer/Lacrosse/Field Hockey (Facilities with up to 2000 spectators)	43.5 footcandles	30 footcandles	2.5:1
Football/Soccer/Lacrosse/Field Hockey (Facilities with up to 5000 spectators)	72.5 footcandles	50 footcandles	2.0:1
Tennis	58 footcandles	40 footcandles	1.7:1 within lines 2.0:1 principal playing area
Gymnasiums (For practice or recreational purposes only)	72.5 footcandles	50 footcandles	2.0:1
Gymnasiums (For hosting events with spectators)	116 footcandles	80 footcandles	2.0:1
Track, Competitive Use	43.5 footcandles	30 footcandles	3.0:1
Track, General Use (walking track)	7.5 footcandles	5 footcandles	NA
Natatoriums	Consult an experienced lighting manufacturer or lighting specialist		
Note: Combination/Multipurpose areas must meet the highest average among the standards for activities played on the field			

Lighting performance requirements for recoverable light loss systems using 0.69 RLLF

NOTE: For facilities with greater than 5000 spectators or that plan on hosting televised events, the facility should be lit according to the NCAA lighting standards for television broadcasts. To access these standards online, go to <http://www.ncaa.org>, then use the site’s search feature to search for “Best Lighting Practices.”

E. Glare for Participants

To achieve placement of lights in positions that enhance playability, pole heights, pole locations, and fixture placements should be as shown on the layouts in the appendix.

1.2 ENVIRONMENTAL LIGHT CONTROL

Many facilities are located near residential properties or roadways, creating the possibility of spill and glare onto adjoining properties. Consideration should be given to this issue during the initial lighting design stage to minimize this effect. Some communities are implementing ordinances designed to minimize light pollution. Contact your local planning committee or zoning board.

The lighting equipment manufacturer can assist in assessing this issue and provide drawings showing maximum footcandles at any points of concern on adjacent properties. Do not hesitate to investigate a manufacturer’s reputation, abilities, and past experiences in working with local authorities and private property owners regarding glare and spill issues.

1.3 LIFE-CYCLE COSTS

Because the efficiency of lighting systems currently available can vary greatly, a life-cycle operating cost analysis should be considered when evaluating lighting systems. Owners should expect a quality lighting system to last a minimum of 25 years.

These standards provide a Life-Cycle Operating Cost Evaluation form on page 11 to assist with the process. Items that should be included are energy consumption based upon the facility’s expected usage, cost for group and spot relamping and maintenance, and any additional savings in energy or labor cost provided by automated on/off control systems.

Contract price and life-cycle operating cost should both be considered in determining a lighting manufacturer for the project.

1.4 CONTROL AND MONITORING SYSTEM

A remote control and monitoring system will provide ease of operation and management for your facility. Manufacturers providing systems with a 25-year warranty will use this system to ensure your lighting performs as required.

A. Remote Monitoring

The system should monitor lighting performance and notify manufacturer if individual luminaire outage is detected so that appropriate maintenance can be scheduled. The manufacturer should notify the owner of outages within 24 hours, or the next business day.

B. Remote Lighting Control

The system should allow owner and users with a security code to schedule on/off system operation via a web site, phone, fax, or email up to 10 years in advance. Manufacturer should provide and maintain a two-way TCP/IP communication link. Trained staff should be available 24/7 to provide scheduling support and assist with reporting needs.

The owner may assign various security levels to schedulers by function and/or fields. This function must be flexible to allow a range of privileges, such as full scheduling capabilities for all fields, to only having permission to execute "early off" commands by phone.

Control unit should accept and store 7-day schedules, be protected against memory loss during power outages, and should reboot once power is regained and execute any commands that would have occurred during outage.

C. Management Tools

Manufacturers should provide a web-based database of actual field usage and provide reports by facility and user group.

D. Communication Costs

Manufacturers should include communication costs for operating the controls and monitoring system for a period of 25 years.

E. Cabinet Construction

Control and Monitoring Cabinet should be constructed of aluminum and rated NEMA Type 4. Cabinet should contain custom-configured contactor modules for 30, 60, and 100 amps, labeled to match field diagrams and electrical design. Manual Off-On-Auto selector switches should be provided.

1.5 WARRANTY AND GUARANTEE

Product warranties are a good gauge of a manufacturer's confidence in their products. Warranties for typical floodlighting equipment can range from five years to 10 years, and details of covered items and conditions vary greatly. New generation technology comes with warranty periods of up to 25 years and includes guaranteed light levels, parts, labor, lamp replacements, energy usage, monitoring and control services, spill light control, and structural integrity. The manufacturer should have financial reserves to assure fulfillment of the warranty for the full term. It is highly recommended you consider these all-inclusive warranties to limit your school's future exposure to escalating costs and maintenance hassles.

PART 2 – PRODUCT

2.1 LIGHTING SYSTEM CONSTRUCTION

A lighting system should consist of lighting, electrical, and structural components designed to work together as a system that is durable and provides safety features.

A. Outdoor lighting systems should consist of the following:

1. Galvanized steel poles and crossarm assembly. Wood poles, direct burial steel poles, or direct burial steel stub base poles are not recommended.
2. Pre-stressed concrete base embedded in concrete backfill allowed to cure for 12 to 24 hours before pole stress is applied. Alternate may be an anchor bolt foundation designed so that the steel pole and any exposed steel portion of the foundation is located a minimum of 18 inches above final grade. The concrete for anchor bolt foundations should be allowed to cure for a minimum of 28 days before the pole stress is applied.

3. Luminaires constructed with a die-cast aluminum housing or external hail shroud to protect the luminaire reflector system.
4. All ballasts and supporting electrical equipment mounted remotely in aluminum enclosures approximately 10' above grade. The enclosures shall include ballast, capacitor, and fusing for each luminaire. Safety disconnect per circuit for each pole structure must be located in the enclosure.
5. Wire harness complete with an abrasion protection sleeve, strain relief, and plug-in connections for fast, trouble-free installation.

B. Interior sports lighting systems should consist of the following:

1. Luminaires that include a lamp, lamp socket, reflector, lens, lamp cone, reinforcing retaining ring, and wire frame to mount glare reduction visor.
2. All ballasts and supporting electrical equipment should be mounted remotely in aluminum enclosures located in an easily-accessible area but away from the playing area due to heat considerations. The enclosures should include ballast, capacitor, and fusing for each luminaire. Safety disconnect per circuit for each pole structure must be located in the enclosure.

C. Manufacturing Requirements

All components should be designed and manufactured as a system. All luminaires, wire harnesses (if provided), and ballast and other enclosures should be factory assembled, aimed, wired, and tested for reduced installation time and trouble-free operation.

D. Durability

All exposed components should be constructed of corrosion-resistant material and/or coated to help prevent corrosion. All exposed steel should be hot-dip galvanized per ASTM A123. All exposed hardware and fasteners should be stainless steel of at least 18-8 grade, passivated and polymer coated to prevent possible galvanic corrosion to adjoining metals. All exposed aluminum should be powder coated with high performance polyester. All exterior reflective inserts should be anodized; coated with a clear, high gloss, durable fluorocarbon; and protected from direct environmental exposure to prevent reflective degradation or corrosion. All wiring should be enclosed within the crossarms, conduit, pole, or electrical components enclosure.

E. Lightning Protection

All outdoor structures should be equipped with lightning protection meeting NFPA 780 standards.

F. Safety

All system assemblies should be UL Listed for the appropriate application.

G. Maximum total voltage drop

Voltage drop to the disconnect switch located on the poles should not exceed three (3) percent of the rated voltage per IESNA RP-6-01, Annex D.

2.2 STRUCTURAL PARAMETERS

A. Location

Poles should be located as shown on the drawings in the appendix to these standards. Whenever possible, poles should be located outside of fences to avoid causing an obstruction or safety hazard to the participants.

B. Foundation Strength

Project-specific foundation drawings stamped by a registered Kentucky structural engineer illustrating that the foundation design is adequate to withstand the forces imposed from the pole, fixtures, and other attachments to prevent the structure from leaning should be provided by the manufacturer.

C. Support Structure Wind Load Strength

Poles and other support structures, brackets, arms, bases, anchorages, and foundations should be determined based on the 50-year mean recurrent isotach wind maps for the appropriate county per the Kentucky State Building Code. Luminaire, visor, and crossarm should withstand 150 mph winds and maintain accurate aiming alignment.

D. Structural Design

The stress analysis and safety factor of the poles should conform to AASHTO Standard Specifications for Structural Supports for Highway Signs, Luminaires, and Traffic Signals.

E. Soil Conditions

The design criteria for these specifications are based on soil design parameters as outlined in the geotechnical report. If a geotechnical report is not available, the foundation design can be based on soils that meet or exceed those of a Class 5 material as defined by 2001 IBC, Table 1804.2-I-A.

PART 3 – EXECUTION

3.1 FIELD QUALITY CONTROL

A. Illumination Measurements

Upon substantial completion of the project and in the presence of the Contractor, Project Engineer, City's Representative, and Manufacturer's Representative, illumination measurements shall be taken and verified. The illumination measurements should be conducted in accordance with IESNA RP-6-01, Annex B.

B. Correcting Non-Conformance

If, in the opinion of the Owner or his appointed Representative, the actual performance levels including footcandles, uniformity ratios, and maximum kilowatt consumptions are not in conformance with the requirements of the performance specifications and submitted information, the Manufacturer shall be liable to any or all of the following:

1. Manufacturer shall at his expense provide and install any necessary additional fixtures to meet the minimum lighting standards. The Manufacturer shall also either replace the existing poles to meet the new wind load (EPA) requirements or verify by certification by a licensed structural engineer that the existing poles will withstand the additional wind load.
2. Manufacturer shall minimize the Owner's additional long term fixture maintenance and energy consumption costs created by the additional fixtures by reimbursing the Owner the amount of \$1,000.00 (one thousand dollars) for each additional fixture required.
3. Manufacturer shall remove the entire unacceptable lighting system and install a new lighting system to meet the specifications.

II. Desirable Features

The following practices are recommended for increasing the lighting system performance.

4.1 TV QUALITY LIGHTING

Lighting for televised events involves considerations in addition to spectators and participants. It is recommended that cities wishing to light facilities for television broadcasts use consultants and lighting manufacturers with experience and knowledge in that area. For facilities with greater than 5000 spectators or that plan on hosting televised events, the facility should be lit according to the NCAA lighting standards for television broadcasts. To access these standards online, go to <http://www.ncaa.org>, then use the site's search feature to search for "Best Lighting Practices."

4.2 AUXILIARY BRACKETS

Sports lighting manufacturers can provide accommodations for mounting auxiliary equipment such as speakers on sports lighting poles. This ensures poles will be sized to accommodate the weight, dimensions, and wind load (EPA) of the additional equipment. Brackets shall be welded to the pole and fabricated from hot-dip galvanized steel with a covered hand hole access and internal wiring in the pole.

4.3 SCOREBOARDS

Incorporating scoreboards onto the lighting poles can provide additional cost savings over installing separate structures. Lighting manufacturers can assist in providing a method for attaching a scoreboard appropriate for the sport.

4.4 FIELD PERIMETER LIGHTING

The parking areas, major areas used for passage, and areas immediately bordering the facilities should be lighted to an average of approximately 2 footcandles. Care should be taken to eliminate darkly shadowed areas.

4.5 EMERGENCY LIGHTING FOR SPECTATOR SEATING AREA

Consideration should be given to providing emergency lighting for spectator seating areas in case of loss of power at indoor and outdoor facilities. Refer to local codes for specific requirements as they apply to athletic facilities.

For additional information, contact the KHSAA office at:

KHSAA
2280 Executive Drive
Lexington, Kentucky 40505
Phone: 859/299-5472
Fax: 859/293-5999

SPORTS LIGHTING LIFE-CYCLE OPERATING COST EVALUATION

This form will assist you in comparing 25-year life-cycle operating costs from multiple manufacturers. Bid proposals should be evaluated based upon compliance with the specifications, contract price, and the following life-cycle operating cost evaluation.

BID ALTERNATE A

MANUFACTURER: _____

A.	Energy consumption ____ Number of luminaires x ____ kW demand per luminaire x ____ kW rate x ____ annual usage hours x 25 years		
B.	Demand charges, if applicable	+	
C.	Spot relamping and maintenance over 25 years Assume ____ repairs at \$ ____ each if not included	+	
D.	Group relamps during 25 years ____ annual usage hours x 25 years / lamp replacement hours x \$125 lamp & labor x number of fixtures	+	
E.	Extra energy used without control system ____% x Energy Consumption in item A.	+	
F.	Extra labor without control system \$____ per hour x ____ hours per on/off cycle x ____ cycles over 25 years	+	
G.	TOTAL 25-Year Life-Cycle Operating Cost	=	

BID ALTERNATE B

MANUFACTURER: _____

A.	Energy consumption ____ Number of luminaires x ____ kW demand per luminaire x ____ kW rate x ____ annual usage hours x 25 years		
B.	Demand charges, if applicable	+	
C.	Spot relamping and maintenance over 25 years Assume ____ repairs at \$ ____ each if not included	+	
D.	Group relamps during 25 years ____ annual usage hours x 25 years / lamp replacement hours x \$125 lamp & labor x number of fixtures	+	
E.	Extra energy used without control system ____% x Energy Consumption in item A.	+	
F.	Extra labor without control system \$____ per hour x ____ hours per on/off cycle x ____ cycles over 25 years	+	
G.	TOTAL 25-Year Life-Cycle Operating Cost	=	

SPORTS LIGHTING SUBMITTAL INFORMATION

Design Submittal Data Checklist and Certification

This form will assist you in comparing proposals from various lighting manufacturers. All items listed below should comply with your project's specification and be submitted according to your pre-bid submittal requirements.

Included	Tab	Item	Description
	A	Letter/Checklist	Listing of all information being submitted must be included on the table of contents. List the name of the manufacturer's local representative and his/her phone number. Signed submittal checklist to be included.
	B	On-Field Lighting Design	Lighting design drawing(s) showing: a. Field Name, date, file number, prepared by, and other pertinent data b. Outline of field(s) being lighted, as well as pole locations referenced to the center of the field (x & y), or home plate for baseball/softball fields. Illuminance levels at grid spacing specified c. Pole height, number of fixtures per pole, as well as luminaire information including wattage, lumens and optics d. Height of meter above field surface e. Summary table showing the number and spacing of grid points; average, minimum, and maximum illuminance levels in foot candles (fc); uniformity including maximum to minimum ratio, coefficient of variance, and uniformity gradient; number of luminaires, total kilowatts, average tilt factor; light loss factor. f. Manufacturers shall provide constant light level or provide both initial and maintained light scans using a maximum 0.69 Light Loss Factor and lamp replacement interval at 2100 hours to calculate maintained values as shown in section 1.1.B.2 of these standards.
	C	Off Field Lighting Design	Lighting design drawings showing spill light levels in footcandles as specified.
	D	Photometric Report (glare concerns only)	Provide photometric report for a typical luminaire used showing candela tabulations as defined by IESNA Publication LM-35-02. Photometric data shall be certified by laboratory with current National Voluntary Laboratory Accreditation Program or an independent testing facility with over 5 years experience.
	E	Life-Cycle Cost calculation	Document life-cycle cost calculations as defined on the Life-Cycle Operating Cost Evaluation. Identify energy costs for operating the luminaires, maintenance cost for the system including spot lamp replacement, and group relamping costs. All costs should be based on 25 Years.
	F	Luminaire Aiming Summary	Document showing each luminaire's aiming angle and the poles on which the luminaires are mounted. Each aiming point shall identify the type of luminaire.
	G	Structural Calculations (if required)	Pole structural calculations and foundation design showing foundation shape, depth backfill requirements, rebar, and anchor bolts (if required). Pole base reaction forces shall be shown on the foundation drawing along with soil bearing pressures. Design must be stamped by a structural engineer in the state where the project is located.
	H	Control and Monitoring	Manufacturer shall provide written definition and schematics for automated control system to include monitoring. They will also provide examples of system reporting and access for numbers for personal contact to operate the system.
	I	Electrical distribution plans	If bidding an alternate system other than the base design, manufacturer must include a revised electrical distribution plan including changes to service entrance, panels and wire sizing, signed by a licensed Electrical Engineer in the state where the project is located.
	J	Performance Guarantee	Provide performance guarantee including a written commitment to undertake all corrections required to meet the performance requirements noted in these specifications at no expense to the owner. Light levels must be guaranteed per the number of years specified.
	K	Warranty	Provide written warranty information including all terms and conditions.
	L	Project References	Manufacturer to provide a list of project references of similar products completed within the past three years.
	M	Product Information	Complete set of product brochures for all components, including a complete parts list and UL Listings.
	N	Non-Compliance	Manufacturer shall list all items that do not comply with the specifications.
	O	Compliance	Manufacturer shall sign off that all requirements of the specifications have been met, and that the manufacturer will be responsible for any future costs incurred to bring their equipment into compliance for all items not meeting specifications and not listed in item N – Non-Compliance

Manufacturer: _____
Contact Name: _____

Signature: _____
Date: ____/____/____

Appendix

Typical Facility Information

Area of Lighting	Playing Dimensions	Lighted Area Dimensions	Grid Spacing
Baseball, Infield	90' x 90'	150' x 150'	30' x 30'
Baseball, Outfield	Dimensions Vary*	Dimensions Vary*	30' x 30'
Softball, Infield	60' x 60'	100' x 100'	20' x 20'
Softball, Outfield	Dimensions Vary*	Dimensions Vary*	20' x 20'
Football	360' x 160'	360' x 180'	30' x 30'
Soccer	360' x 180'	360' x 180'	30' x 30'
Lacrosse	330' x 180'	330' x 180'	30' x 30'
Field Hockey	300' x 180'	300' x 180'	30' x 30'
Tennis	78' x 36'	100' x 60'	20' x 20'
Gymnasium	90' x 50'	100' x 50'	10' x 10'
Track and Field	Dimensions Vary	Dimensions Vary	30' x 30'

* Baseball and softball fields are pie-shaped. Outfield areas are derived from the overall area less the lighted infield area.

Light Level Grid Point Layouts

Baseball

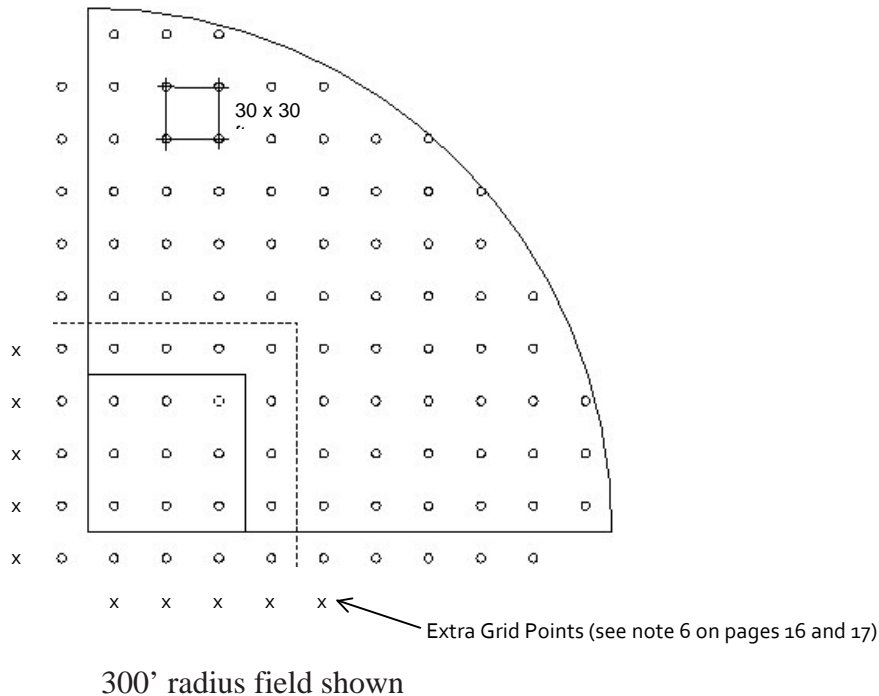

Softball

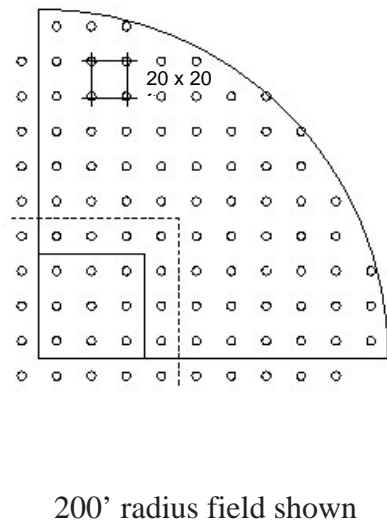

Football

360' x 160' field shown

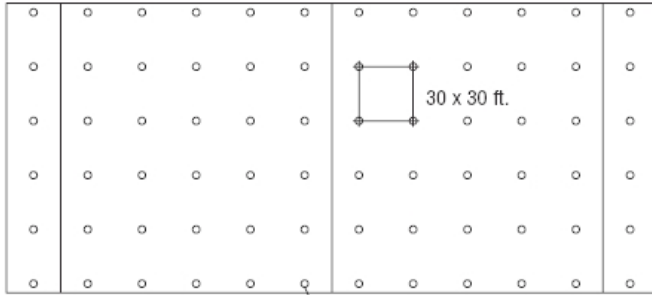

Grid Points

Gymnasium

94' x 50' court shown

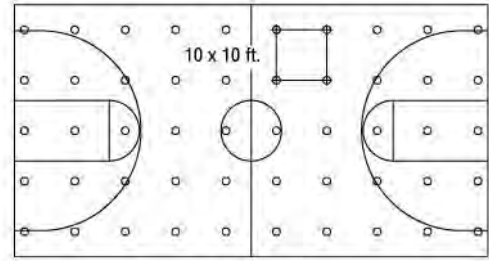

Soccer

360' x 180' field shown

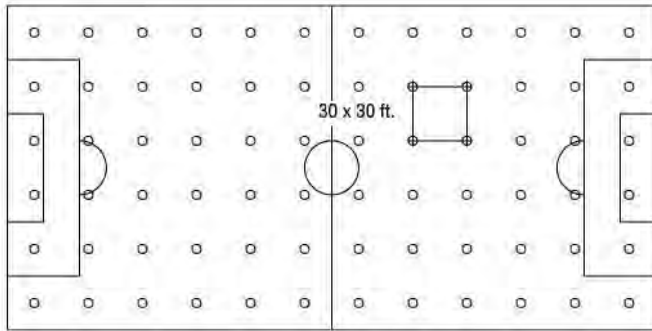

Tennis

78' x 36' court shown

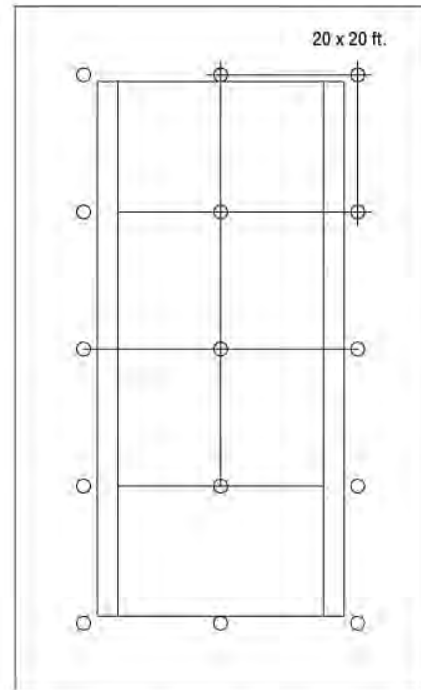

Track

400 meter,

8 lane track shown

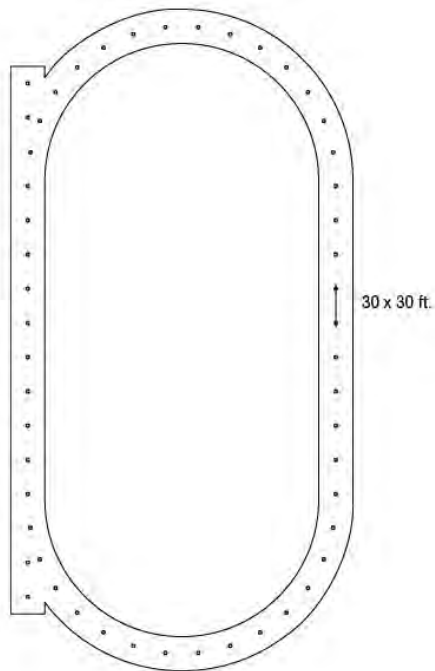

Lacrosse

330' x 180' field shown

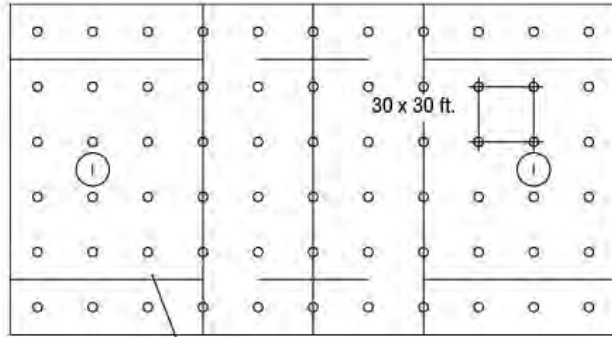

Grid Points

Field Hockey

300' x 180' field shown

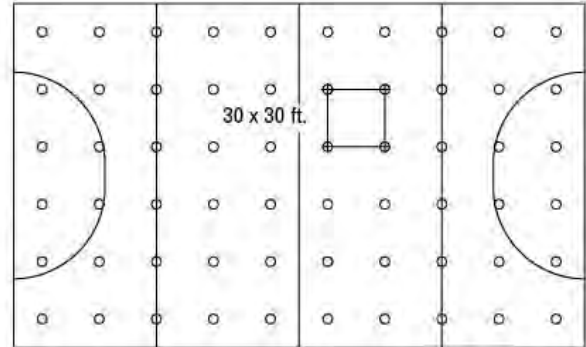

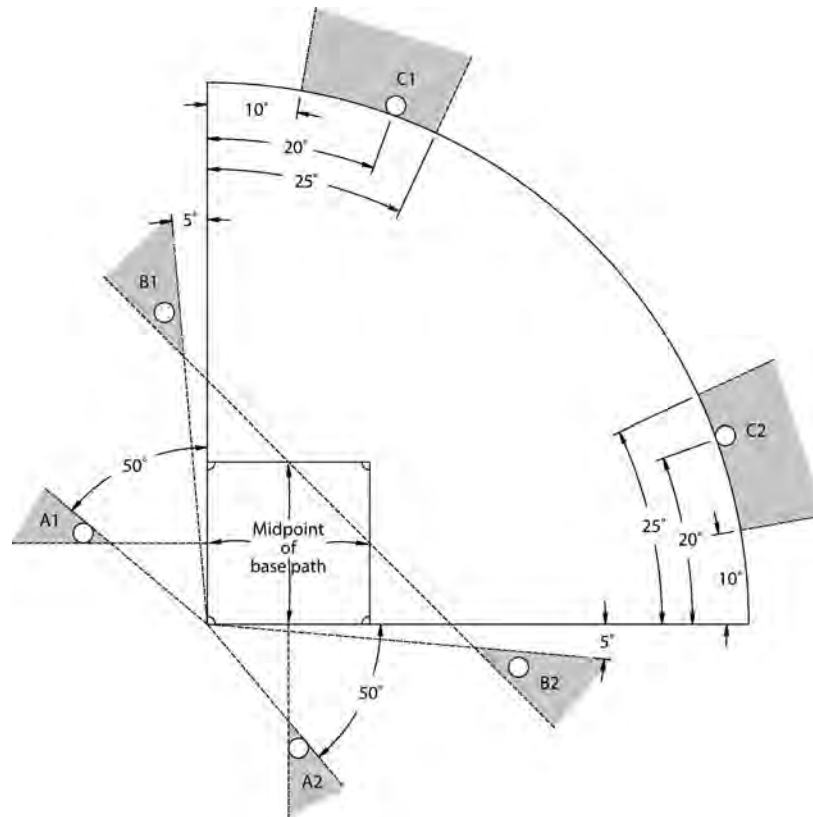

6-Pole Baseball/Softball Field

1. Poles are shown in optimal locations. Other permissible pole locations are indicated by the shaded areas.
2. For fields with a radius of 320 feet or greater, an 8-pole design is recommended.
3. Line drawn through the two “A” pole locations should be behind home plate to ensure the ball is properly lit as it crosses home plate.
4. Consideration should be given to locating “B” poles further toward the outfield locations. This positioning towards the outfield foul pole allows the ball to be lighted in a more constant perpendicular illuminance as it travels from the infield to the outfield.
5. Vertical aiming angle should be 25 degrees minimum on fixtures aimed to the infield and 21 degrees minimum on fixtures aimed to the outfield. The angles are measured from below a horizontal plane at fixture height.
6. If the distance between home plate and the backstop is greater than 40 feet, an additional grid should be created to include 10 additional grid points. The average light level for this additional grid should meet or exceed the design criteria for the outfield points.

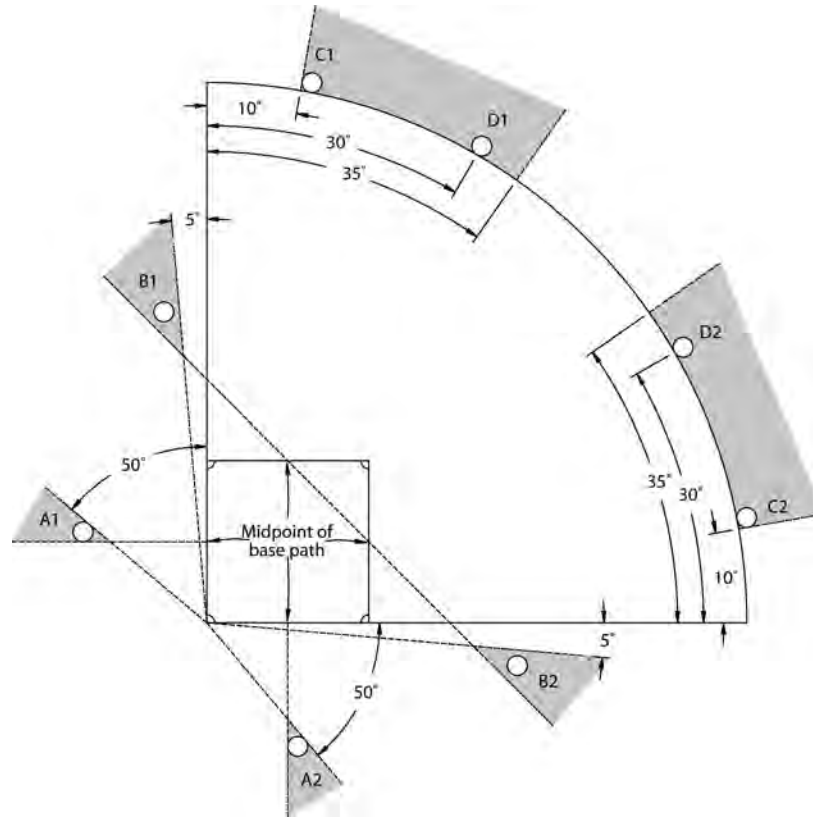

8-Pole Baseball/Softball Field

1. Shaded areas indicate recommended pole location.
2. Line drawn through the two “A” pole locations should be behind home plate to ensure the ball is properly lit as it crosses home plate.
3. Consideration should be given to locating “B” poles further towards outfield locations. This positioning towards the outfield foul pole allows the ball to be lit in a more constant perpendicular illuminance as it travels from the infield to the outfield.
4. “B” poles may be located 10 feet closer to the infield as long as they maintain a position outside the 10 degree arc. The shaded area is preferable.
5. Vertical aiming angle should be 25 degrees minimum on fixtures aimed to the infield and 21 degrees minimum on fixtures aimed to the outfield. The angles are measured from below a horizontal plane at fixture height.
6. If the distance between home plate and the backstop is greater than 40 feet, an additional grid should be created to include 10 additional grid points. The average light level for this additional grid should meet or exceed the design criteria for the outfield points.

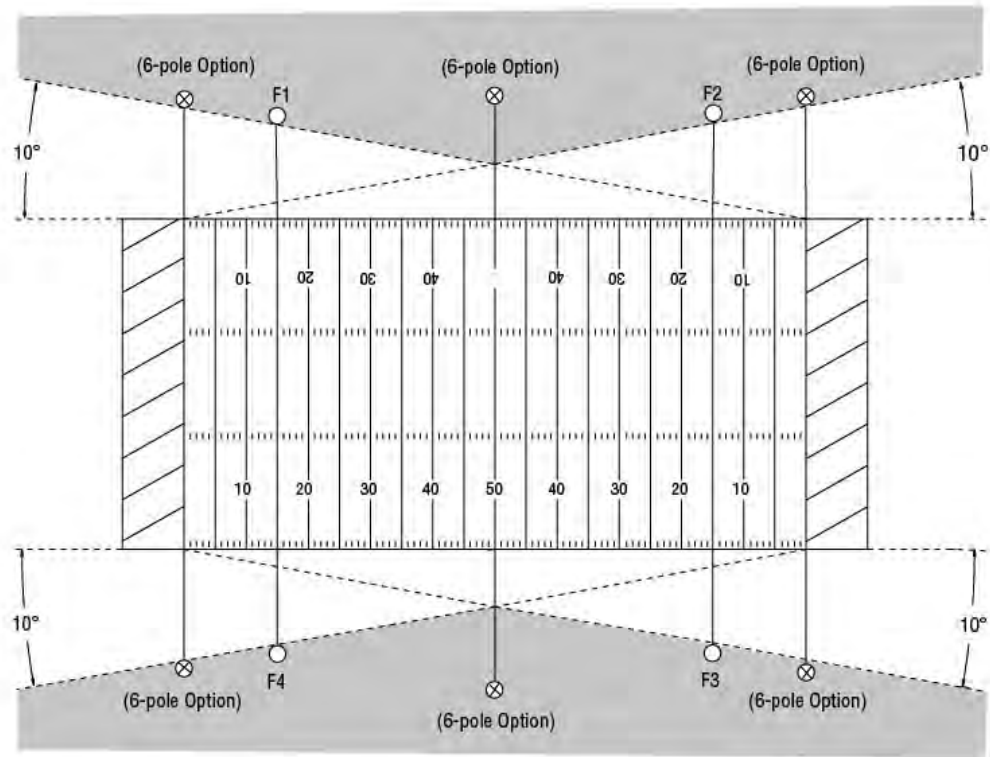

Football Field

1. Poles are shown in optimal locations. Other permissible pole locations are indicated by the shaded areas. All poles should be at least 30 feet from the sideline.
2. On a 4-pole design, the optimum location is on the 15 yard line.
3. For the 6-pole option, setback of middle poles will depend on the presence of bleachers. The optimum location for the corner poles is between the goal line and the corner of the field.
4. Poles should be positioned so as not to pose a potential injury hazard.
5. Vertical aiming angles should be 21 degrees minimum. The angles are measured from below a horizontal plane at fixture height.

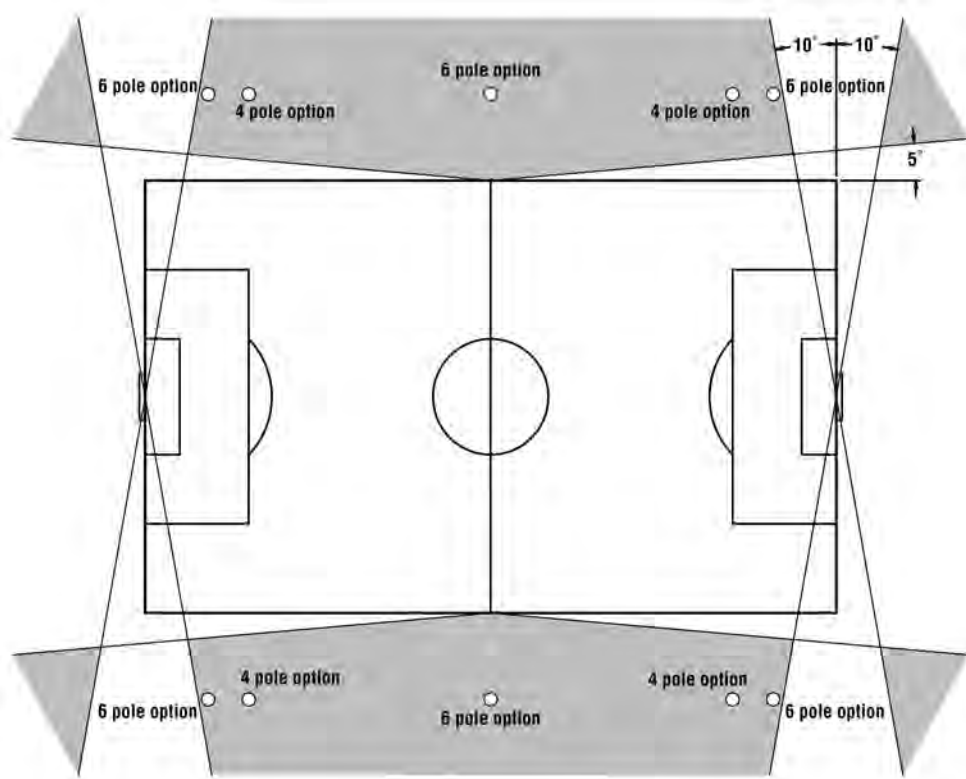

Soccer Field

1. Poles are shown in optimal locations. Other permissible pole locations are indicated by the shaded areas. All poles should be at least 20 feet from the sideline.
2. On a 4-pole design, the optimum pole locations are .35 x field length from center of field.
3. In general, football lighting standards apply to soccer with the following considerations:
 - a. Soccer field length generally ranges from 300 to 360 feet; width varies from 160 to 225 feet.
 - b. A corner kick is a specific visual task and general considerations should be given to facility design specifically for soccer.
 - c. The corner grid point should be lit to no less than 90% of the average light level.
4. For combination football and soccer facilities, soccer should take precedence.
5. Vertical aiming angles should be 21 degrees minimum. The angles are measured from below a horizontal plane at fixture height.

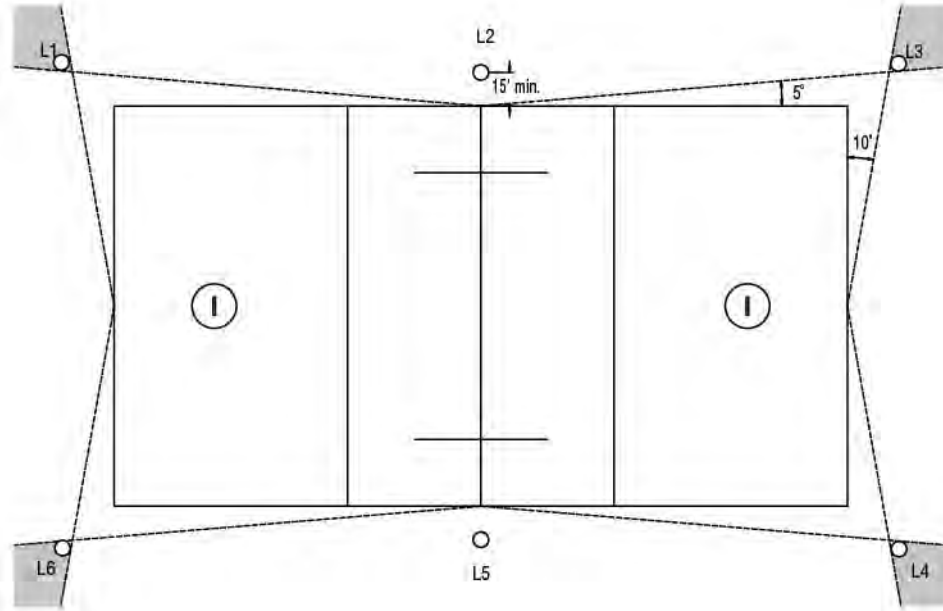

Lacrosse Field

1. Poles are shown in optimal locations. Other permissible pole locations are indicated by the shaded areas. All poles should be at least 15 feet from the sideline.
2. Vertical aiming angle should be 21 degrees minimum. The angles are measured from below a horizontal plane at fixture height.
3. A 4-pole design utilizing corner location is permissible providing minimum aiming angles can be achieved.

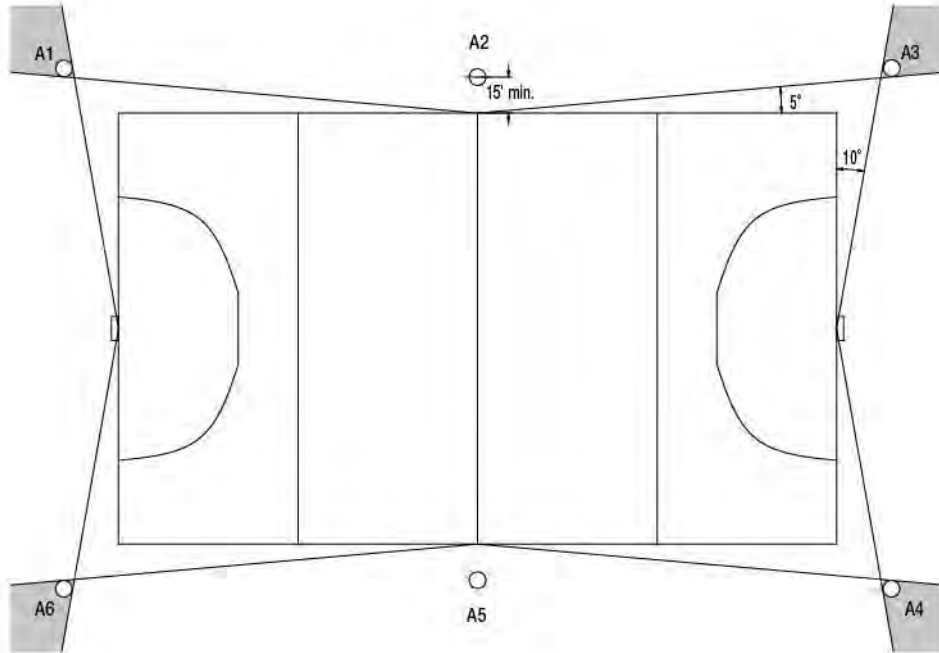

Field Hockey Field

1. Poles are shown in optimal locations. Other permissible pole locations are indicated by the shaded areas. All poles should be at least 15 feet from the sideline.
2. Vertical aiming angle should be 21 degrees minimum. The angles are measured from below a horizontal plane at fixture height.
3. A 4-pole design utilizing corner location is permissible providing minimum aiming angles can be achieved.

12 Fixture Design

Designed for lighting in gymnasiums with no special provision for spectators such as smaller high schools or training facilities.

- 54 footcandles maintained

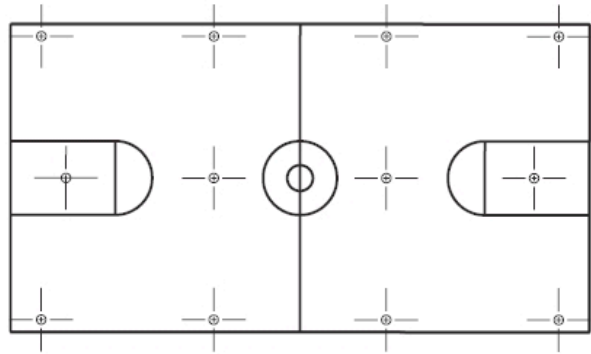

20 Fixture Design

Ideal for college, semi-professional, or large high schools with facilities for spectators of 5000 or less. Suitable for facilities where lighted surfaces are 50' x 94' with 22' mounting heights.

- 80 footcandles maintained

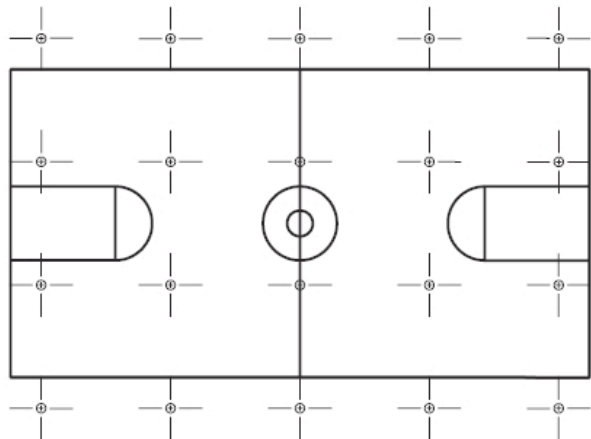

Gymnasium

1. For new facilities or upgrades, it is recommended to consult a lighting professional for optimal fixture placement.
2. Optimal fixture placement and mounting heights will impact playability and minimize glare and skip glare.
3. As a general rule, due to mounting heights, lower wattage fixtures are used, commonly 1000 watt.

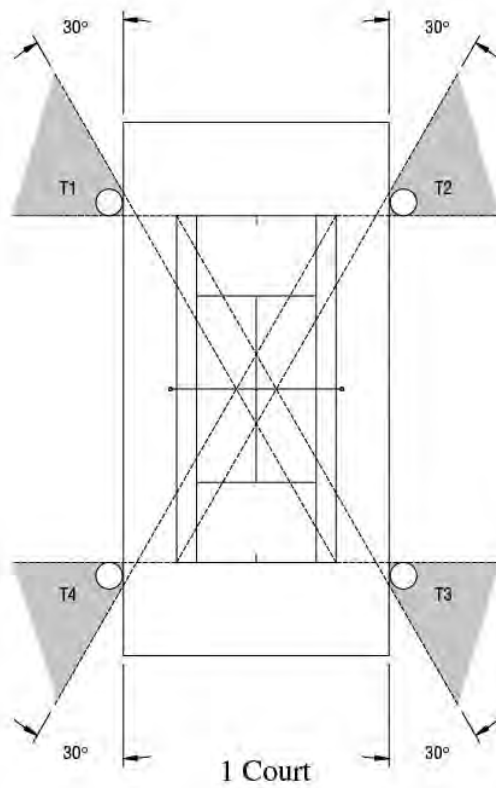

Tennis Courts

1. Poles are shown in optimal locations. Other permissible pole locations are indicated by the shaded areas.
2. It is not generally recommended to use a 6-pole layout with poles located at net lines. This position may be directly in the server's sight line with toss when the ball is served.
3. Vertical aiming angles should be 25 degrees minimum. The angles are measured from below a horizontal plane at fixture height.

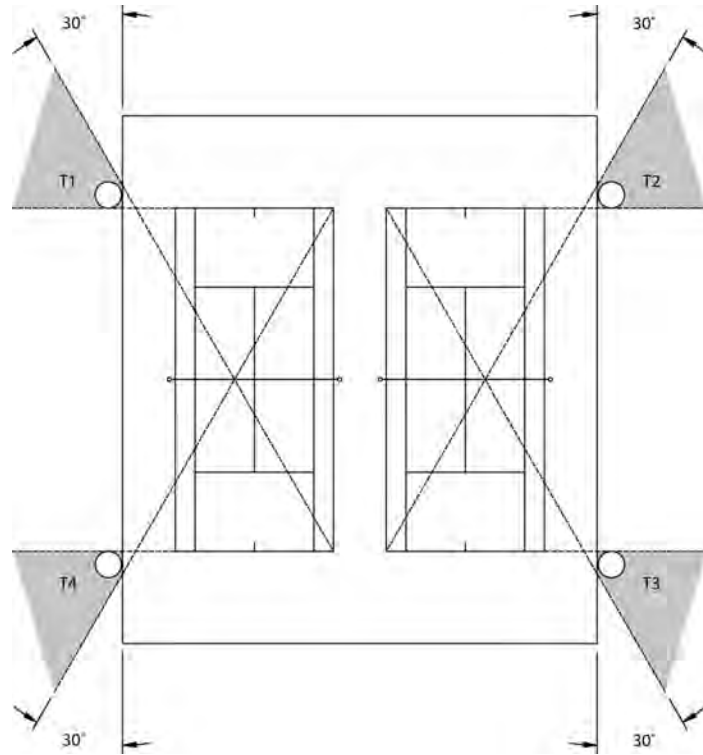

2 Courts

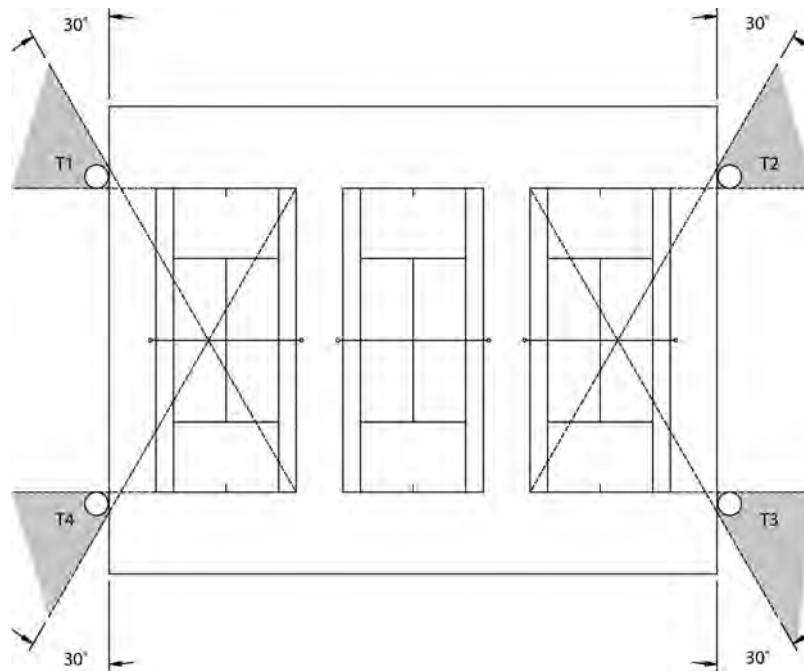

3 Courts

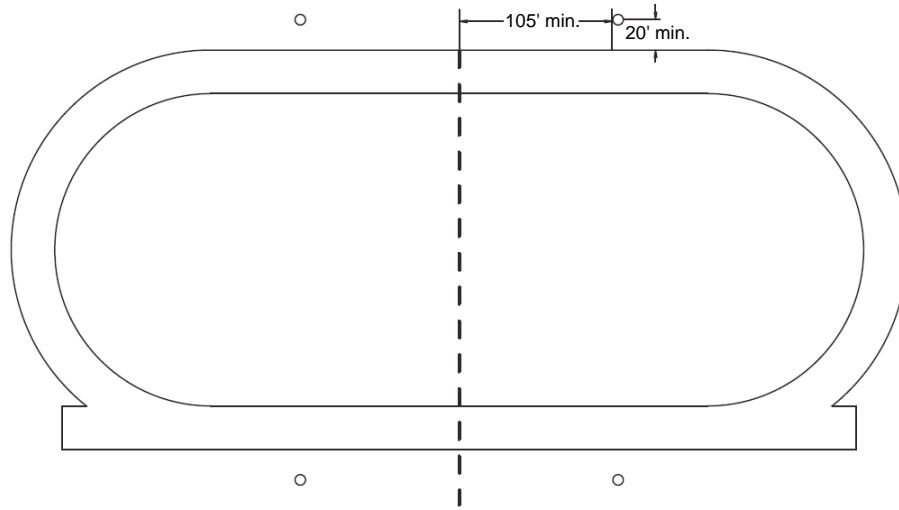

4-Pole Track

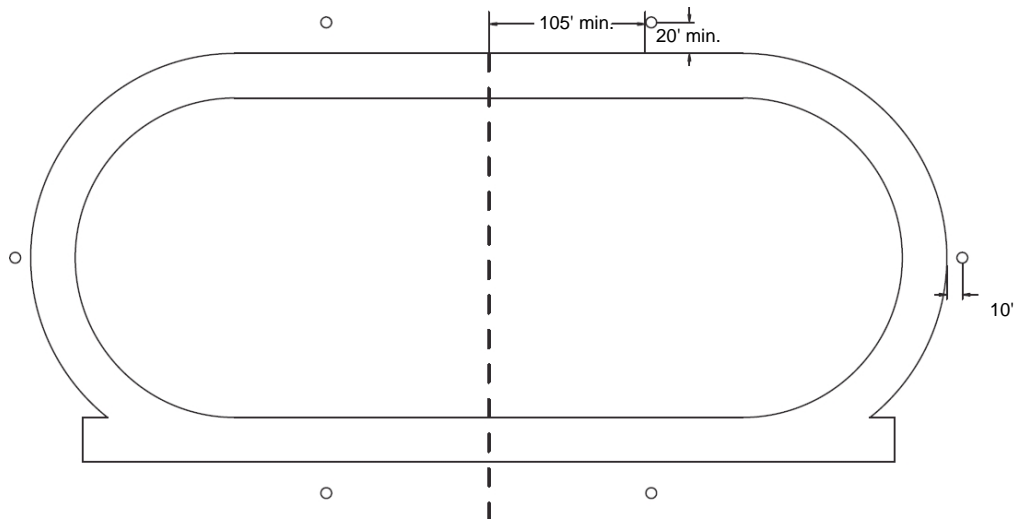

6-Pole Track

400 Meter, 8 Lane Track

1. These pole locations are for typical stand-alone tracks.
2. For tracks built in conjunction with a football or soccer field, use the standard pole locations on the football design (page 19) or soccer design (page 20).
3. Vertical aiming angles should be 21 degrees minimum. The angles are measured from below a horizontal plane at fixture height.

ANNUAL SYSTEM OPERATION & MAINTENANCE CHECKLIST

Needs
OK Repair Notes:

WARNING!! Turn off electricity at power source and at safety disconnect on the pole.

Lighting Performance Testing		OK	Repair	Notes:
Use test forms for appropriate sport following this checklist				
<ul style="list-style-type: none"> Average footcandles meet guidelines Average uniformity meets guidelines 				
Service Entrance & Pole Distribution Boxes				
Check service panel for proper markings.				
<ul style="list-style-type: none"> Emergency information should be visible. Warning stickers, wiring diagrams, circuit labels and other servicing information signs should be posted and clearly legible. 				
Test reset action on all service breakers.				
<ul style="list-style-type: none"> Snap all breakers on and off several times to ensure firm contact. If fuses are used at main service, check continuity.* 				
Check the wiring.				
<ul style="list-style-type: none"> Insulation around wiring should show no signs of deterioration. Wiring should show no heat discoloration. 				
Check all taped connections.				
<ul style="list-style-type: none"> Signs of wear should be replaced. 				
Make sure no live parts are exposed.				
<ul style="list-style-type: none"> Bare wires and exposed connections should be wrapped with insulated covering.* 				
Padlocks for service entrance & distribution boxes should be in place and operational.				
Poles				
Wood poles:				
Check to see that poles aren't leaning.				
<ul style="list-style-type: none"> Leaning poles may be unsafe and replacement or re-installation and/or re-aiming may be necessary. 				
Check for twisting.				
<ul style="list-style-type: none"> If poles have moved, re-aiming of the fixtures may be necessary. 				
Check for decay.				
<ul style="list-style-type: none"> Wood poles decay from the inside out. Core testing is the best method to determine the condition and safety of the pole. 				
Steel poles:				
Check baseplate for signs of deterioration caused by corrosion or fatigue.				
<ul style="list-style-type: none"> Check anchor bolt for signs of corrosion. Check grouting under pole to make sure proper drainage exists. 				
Check for all pole access covers, replace missing covers.				
Cables and conduit:				
<ul style="list-style-type: none"> Pull on conduit to check for looseness. Check for loose fittings and damaged conduit. All cables should be straight and properly strapped.* If cables are exposed to the elements, make sure the insulation has the proper rating.* 				
Check overhead wiring.				
<ul style="list-style-type: none"> Wiring should be properly secured. Check that new growth on tree branches and limbs won't obstruct or interfere with overhead wiring. 				
Luminaires				
Check fixture housings.				
<ul style="list-style-type: none"> Housings should show no sign of cracking and/or water leakage. 				
Check lenses.				
<ul style="list-style-type: none"> Clean lenses. Replace broken lenses. 				
Replace burned-out lamps.				
Check luminaire fuses.				
<ul style="list-style-type: none"> Replace burned-out fuses. Fuses should be the correct size. 				
Insulation covering on wiring should show no signs of wear or cracking.				
Ground wire connections must be secure.				
Check around ballasts for signs of blackening.				
Check that capacitors aren't bulging.				
Check aiming alignment of all fixtures.				
<ul style="list-style-type: none"> On wooden poles, see if crossarms are still aligned with the field and horizontal. 				
Ground				
Check grounding connections.*				
Check nearby metal objects.				
<ul style="list-style-type: none"> Make sure metal bleachers and other metal objects are located at least 6 feet from the electrical components. Metal objects, such as bleachers, must have their own individual grounding system. 				

* These tests and/or repairs require the services of a qualified electrician.

Lighting Performance Testing

To verify that your field meets the recommended standards, complete the performance testing information below. The inspection must be done using a light meter calibrated within the last 12 months. The light meter should be held horizontally 36 inches above the middle point of each square in the grid.

Baseball/Softball

To obtain average footcandle value:

Record light readings within each square.

Infield = Total of infield readings \div 25

Outfield = Total of outfield readings \div number of readings.

To obtain uniformity ratio for infield or outfield:

Divide highest (maximum) light level reading by the lowest (minimum) light level reading:

Maximum reading _____ \div Minimum reading _____ = _____ Uniformity ratio

For example:

61 footcandles \div 31 footcandles = 2.1

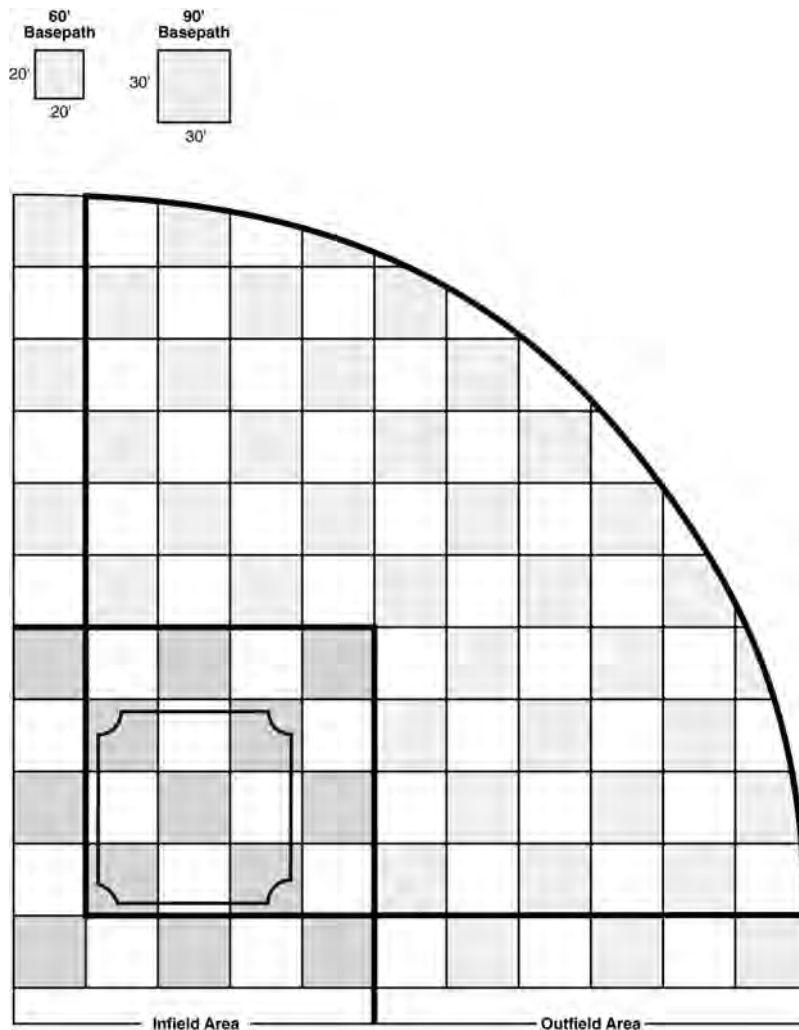

Football

To obtain average footcandle value:

Record light readings within each square.

Total all readings, and divide by total number of readings taken.

To obtain uniformity ratio:

Divide highest (maximum) light level reading by the lowest (minimum) light level reading:

Maximum reading _____ ÷ Minimum reading _____ = _____ Uniformity ratio

30' by 30' grid

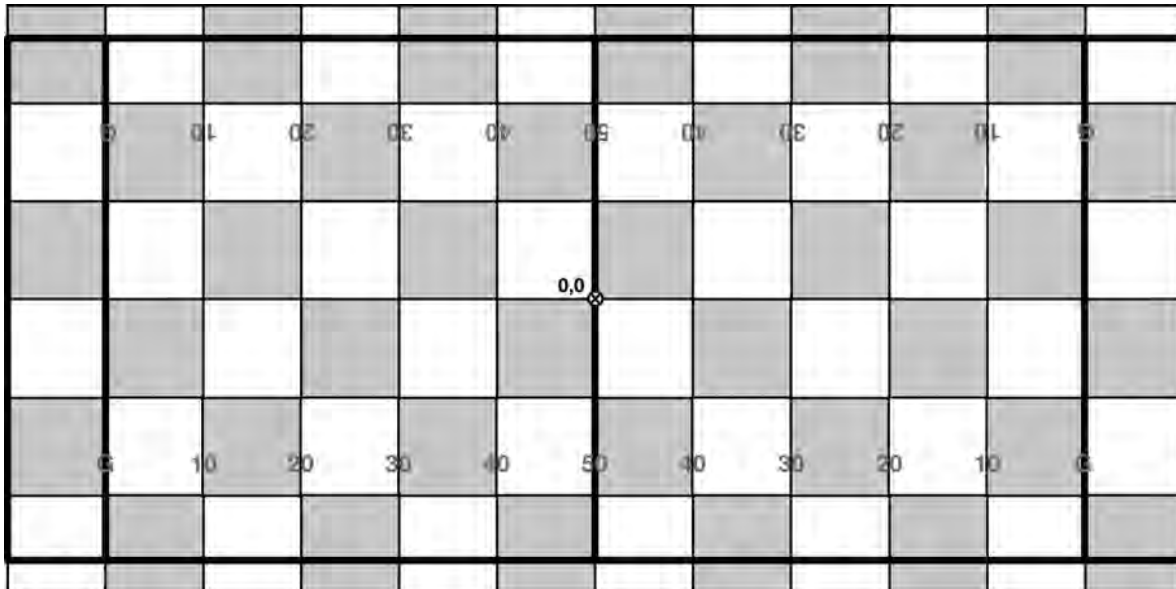

Soccer

To obtain average footcandle value:

Record light readings within each square.

Total all readings, and divide by total number of readings taken.

To obtain uniformity ratio:

Divide highest (maximum) light level reading by the lowest (minimum) light level reading:

Maximum reading _____ ÷ Minimum reading _____ = _____ Uniformity ratio

30' by 30' grid

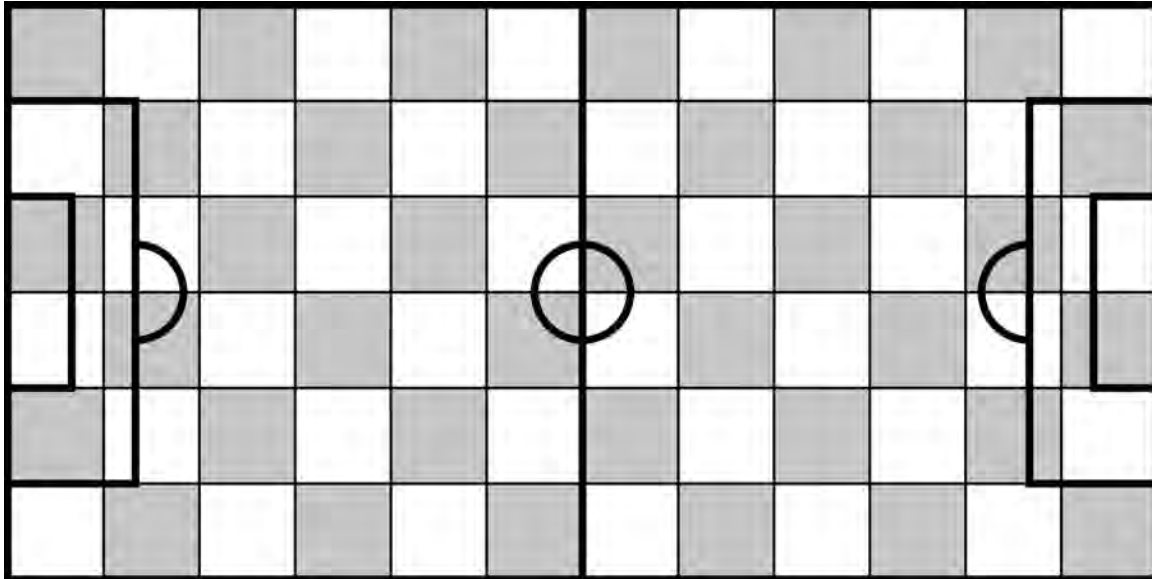

Lacrosse

To obtain average footcandle value:

Record light readings within each square.

Total all readings, and divide by total number of readings taken.

To obtain uniformity ratio:

Divide highest (maximum) light level reading by the lowest (minimum) light level reading:

Maximum reading _____ ÷ Minimum reading _____ = _____ Uniformity ratio

30' by 30' grid

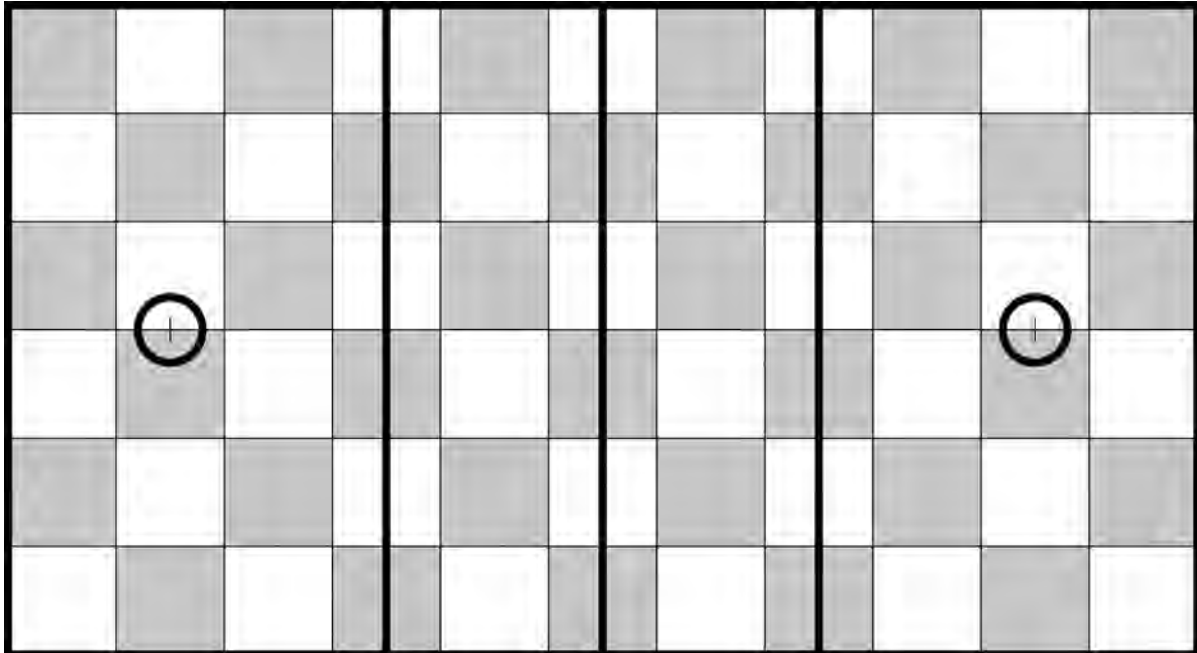

Field Hockey

To obtain average footcandle value:

Record light readings within each square.

Total all readings, and divide by total number of readings taken.

To obtain uniformity ratio:

Divide highest (maximum) light level reading by the lowest (minimum) light level reading:

Maximum reading _____ ÷ Minimum reading _____ = _____ Uniformity ratio

30' x 30' grid

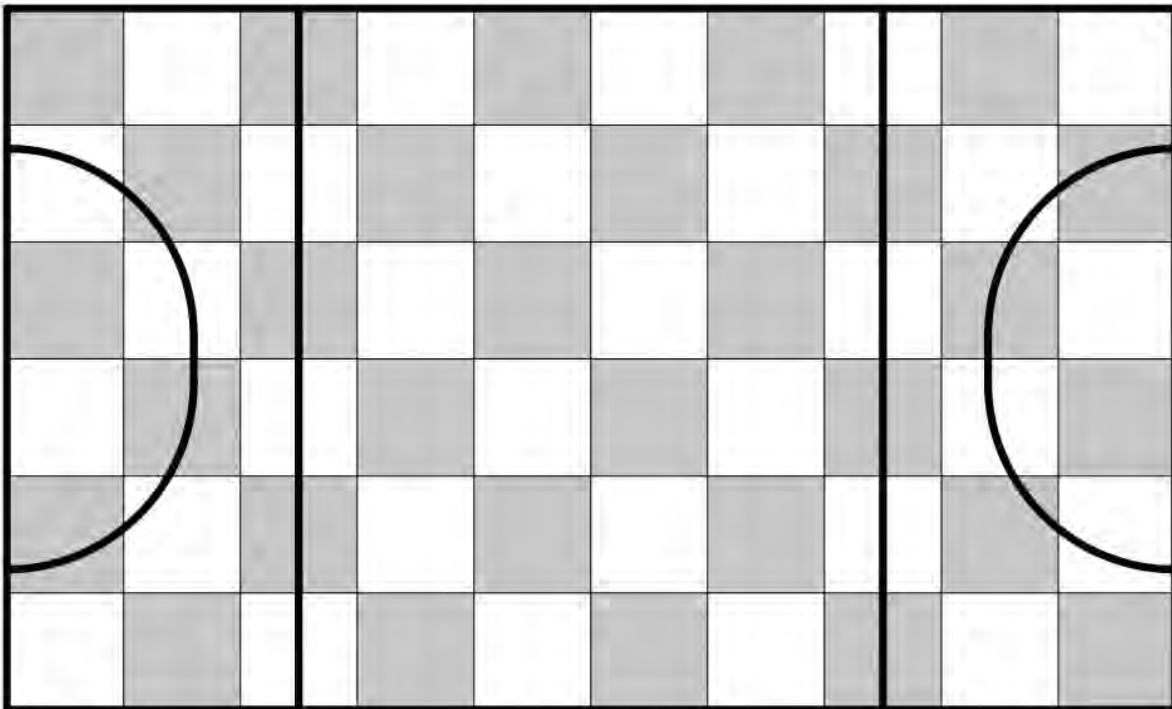

Gymnasium

To obtain average footcandle value:

Record light readings within each square.

Total all readings, and divide by total number of readings taken.

To obtain uniformity ratio:

Divide highest (maximum) light level reading by the lowest (minimum) light level reading:

Maximum reading _____ ÷ Minimum reading _____ = _____ Uniformity ratio

10' by 10' grid

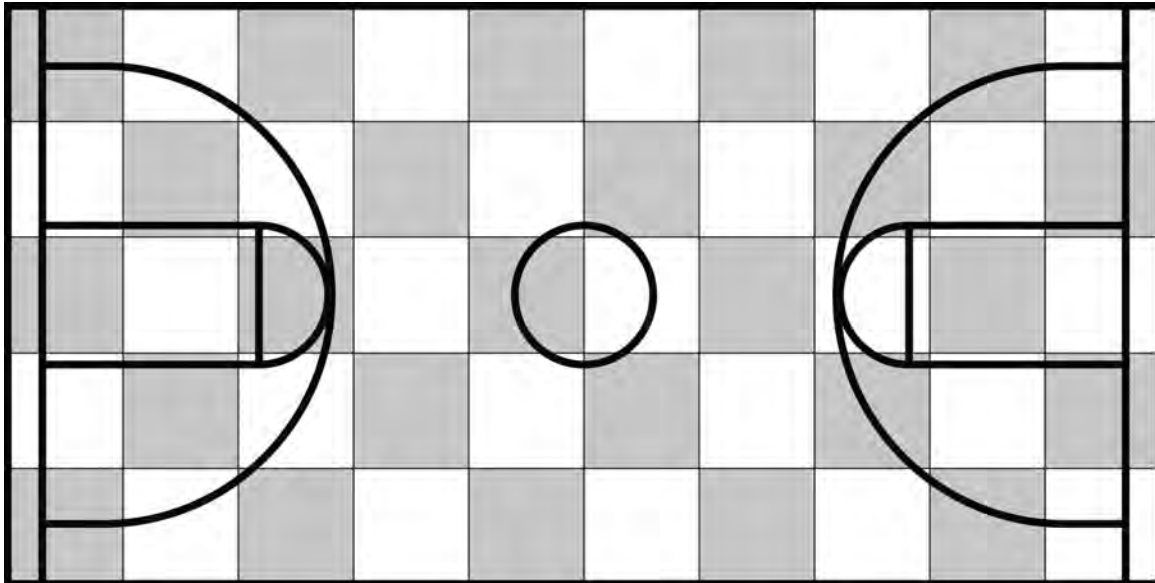

Tennis

To obtain average footcandle value:

Record light readings within each square.

Total all readings, and divide by total number of readings taken.

To obtain uniformity ratio:

Divide highest (maximum) light level reading by the lowest (minimum) light level reading:

Maximum reading _____ ÷ Minimum reading _____ = _____ Uniformity ratio

20' by 20' grid

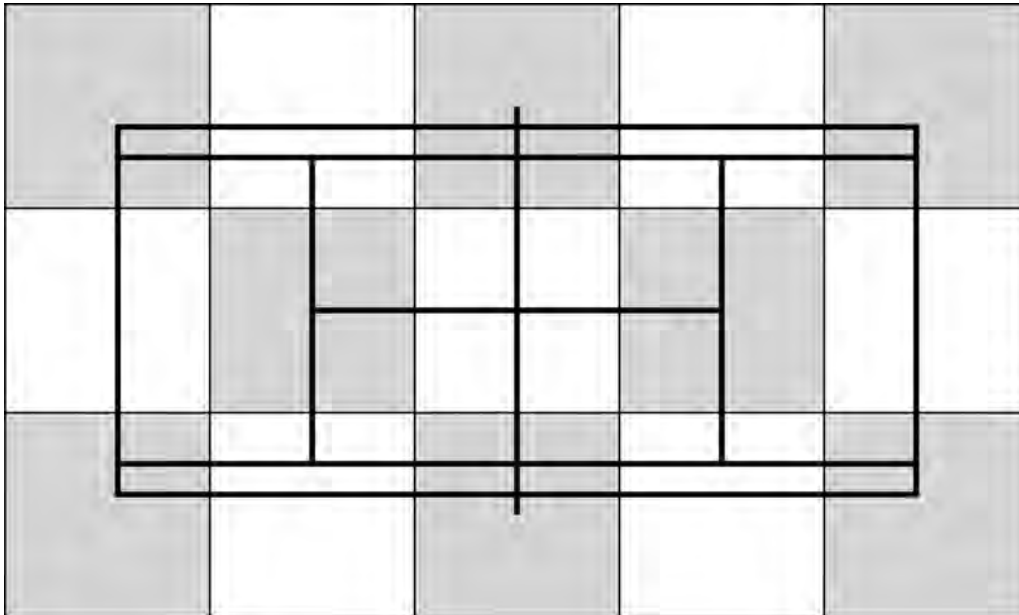

Track

To obtain average footcandle value:

Record light readings within each square.

Total all readings, and divide by total number of readings taken.

To obtain uniformity ratio:

Divide highest (maximum) light level reading by the lowest (minimum) light level reading:

Maximum reading _____ ÷ Minimum reading _____ = _____ Uniformity ratio

30' by 30' grid

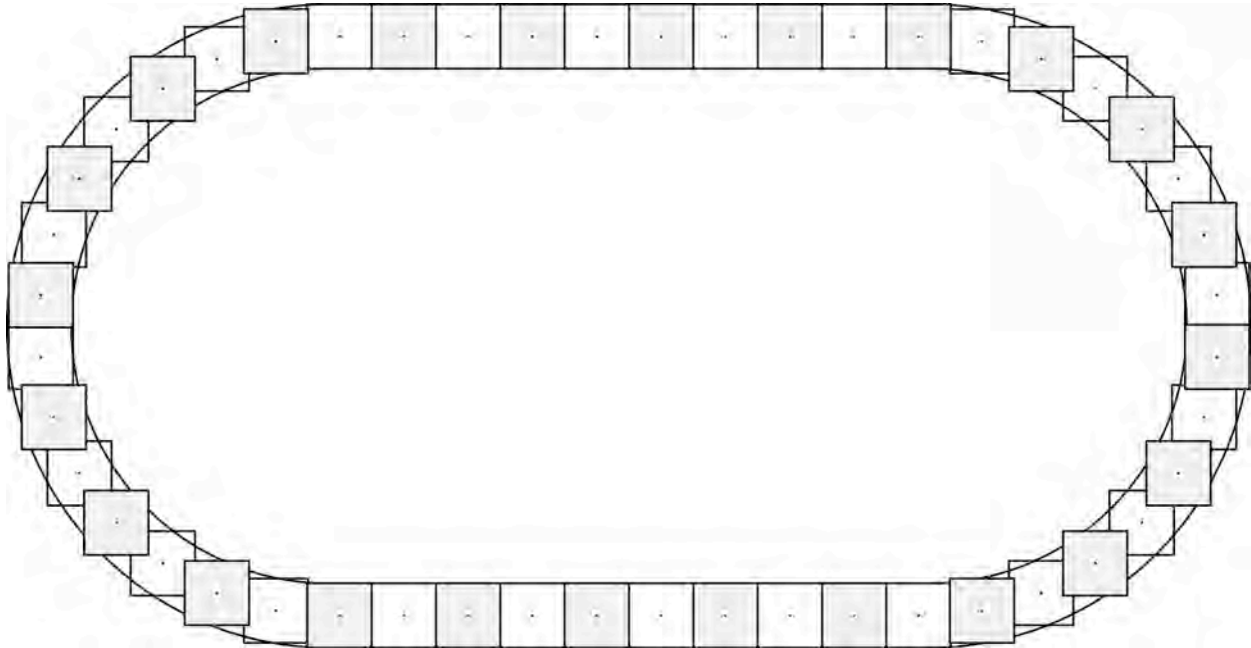

Glossary

Aiming Angles (vertical) The degrees below horizontal that light fixtures are aimed at the field. Angles are measured from a horizontal plane at fixture height. Critical in safe, playable lighting design.

Ballast A transformer that delivers the proper operating voltage for high intensity discharge type lamps including metal halide lamps.

Constant Light Method for achieving target light levels throughout the life of a lamp by utilizing power adjustments.

Footcandle The measurement of light on a surface. One footcandle equals one lumen spread over one square foot.

Glare Light that interferes with the ability to see. Luminaire design, proper aiming angles, and pole locations are key to limiting glare for participants and spectators.

IESNA Illuminating Engineering Society of North America. An organization that develops recommendations for sports lighting.

Initial Light Levels The average light levels when your lamps are new. Manufacturers that do not provide constant illumination should provide scans showing what these levels will be.

Lumen A quantity measurement of light, used mostly in measuring the amount of light a lamp develops.

Metal Halide Lamp A lamp that generates light by passing electrical current through metallic gases. The first choice for sports facilities because of efficiency and color.

NEC National Electric Code. A national safety code for electrical systems that is the basis for most local codes.

NEMA Type A classification of reflectors. For example, a Nema 2 reflector gathers light in a narrow, focused beam, allowing it to be projected a long distance. A Nema 5 projects light a relatively short distance in a very wide beam. Most lighting designs use various combinations of Nema types to get the desired results.

NFPA National Fire Protection Association. An organization that establishes and publishes various codes such as the Lightning Protection Code and the National Electric Code.

Overturning Moment The amount of force applied to a lighting structure, mostly from wind. Pole foundations must be designed to withstand this force.

Reflector Key element of lighting optics. It surrounds the lamp (bulb) and directs light to the field. The efficiency of the reflector is one factor that determines how many light fixtures you have to buy and maintain.

Remote Electrical Enclosure A weatherproof enclosure that allows the electrical gear to be moved from the top of lighting structures to a lower point where it can be serviced easily.

Smoothness The change in light levels between measuring points. The less change between points, the more even the lighting. (See also Uniformity.)

Spill Light Wasted light that falls off the field or is projected into the sky. Systems that can re-direct spill light back onto the field save dollars and keep neighbors content.

Target Light Levels The lowest average amount of light for which a lighting system should operate over its extended life to ensure performance requirements. Target values should be no more than 70% of initial values to be sure that lamp depreciation has been accounted for in the design. You should receive scans showing what this level will be.

Tilt Factor Most lamps generate fewer lumens when tilted off of either a horizontal or vertical position. Your design should show actual tilt factor used in your design.

Underwriters Laboratories Independent, non-profit, product safety testing and certification organization. Visit www.ul.org for additional information.

Uniformity The smoothness of light on the field. Also called uniformity ratio. A design criteria to assure that light is distributed evenly across the entire field. A max/min ratio of 2:1 means that the brightest point is no more than double any other point.

Kentucky High School Athletic Association

2280 Executive Drive

Lexington, Kentucky 40505

Phone: 859/299-5472

Fax: 859/293-5999

Home page: www.khsaa.org

Email: general@khsaa.org